

HANGING MODULAR SYSTEM



Available modules

- Available heights: 1m & 1.5m

M/H/0001 0.5x0.5x1m - Corner



M/H/0029 0.5x1m - Extension



M/H/0002 1x1m - Extension



M/H/0003 2x1m - Extension



M/H/0004 0.5x1m - Ending Set



0.5x0.5x1m - Round r=0.5m



Hanging Clip



Connection



Fastening - 1

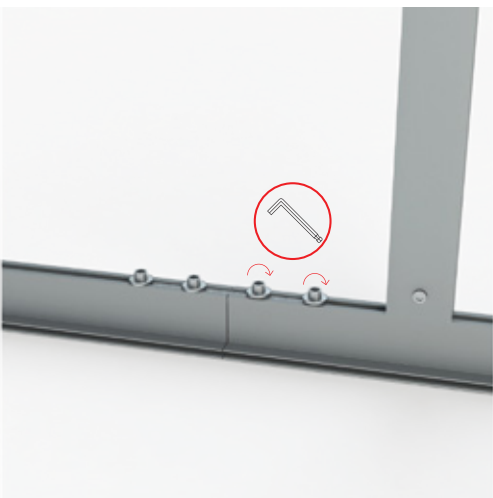

Fastening - 2

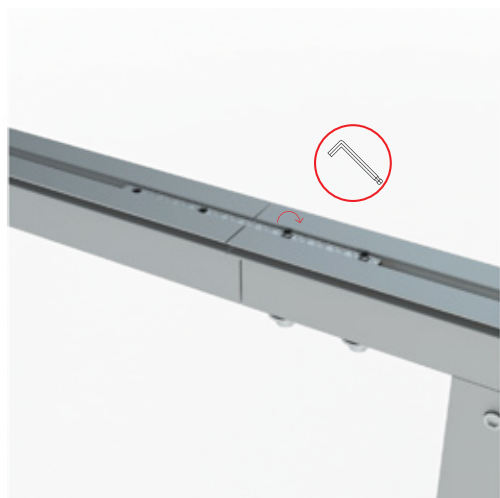

Printing view (outside)



Printing view (inside)



Possibilities

- No maximum length restriction

From 1x1x1m up to 1x2x1m

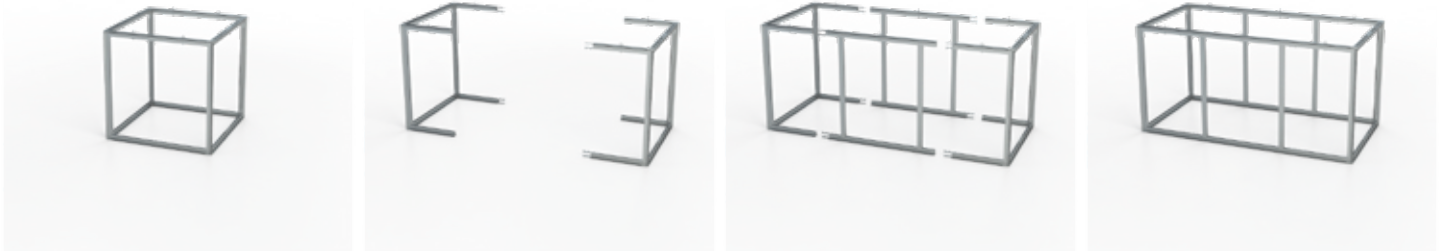

From 1x2x1m up to 1x4x1m



From 1x4x1m up to 2x4x1m



Size 2x4x1m



Rounded rectangle

Rounded rectangle 3x2x1m with r50

It consists of:

- 4 Round parts (r)0.5x1m
- 8 Ending Set (M/H/0004) 0.5x1m
- and 2 extensions (M/H/0002) 1x1m

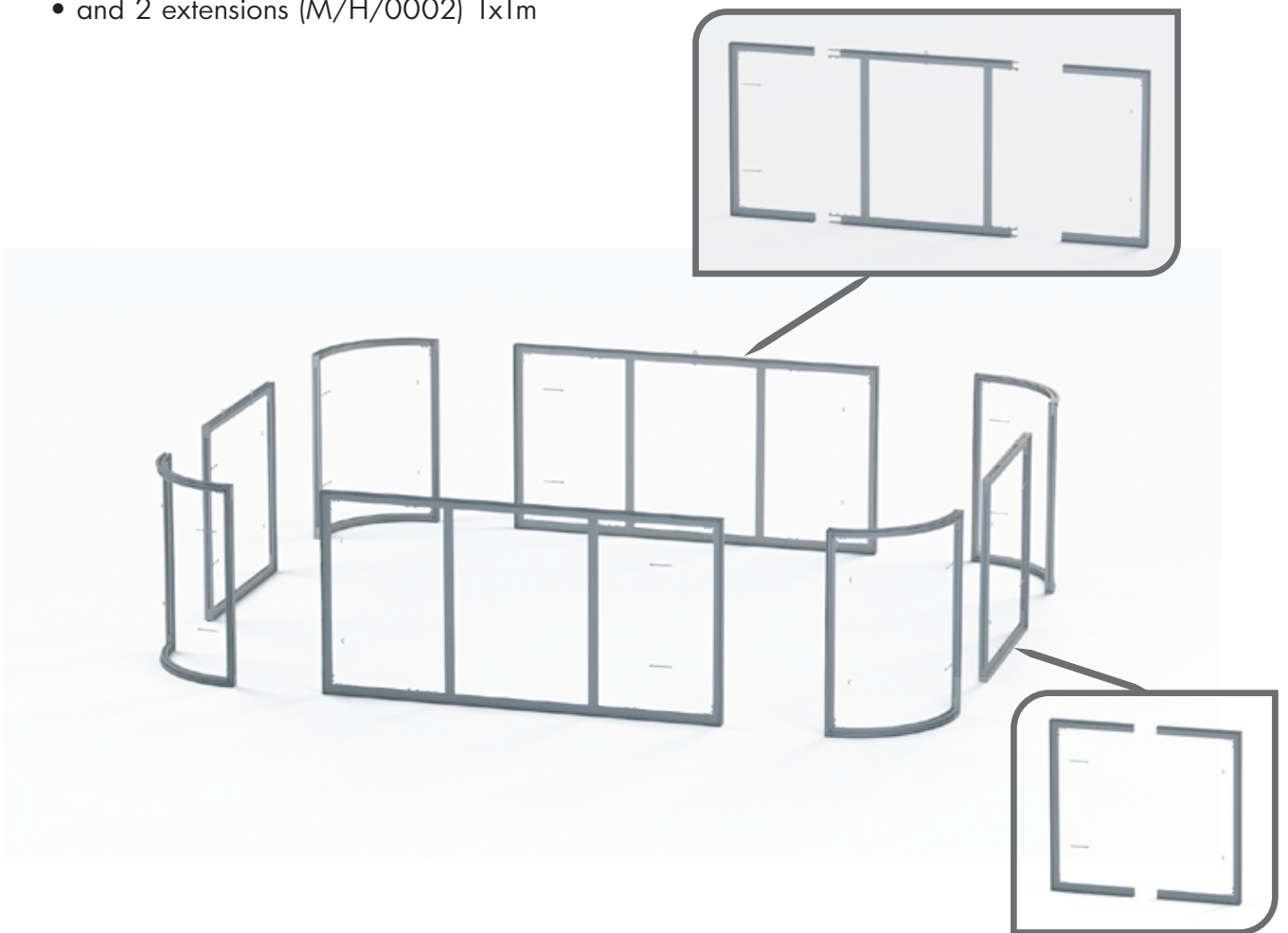

Cylindered

- Available diameters: 1.5m, 2m, 3m, 4m & 5m
- Available heights: 1m & 1.5m

150(d)x100(h)cm consisting of 2 parts 0.75(r)m



Rounded rectangle 1.5x2.5x1m with 0.75(r)m

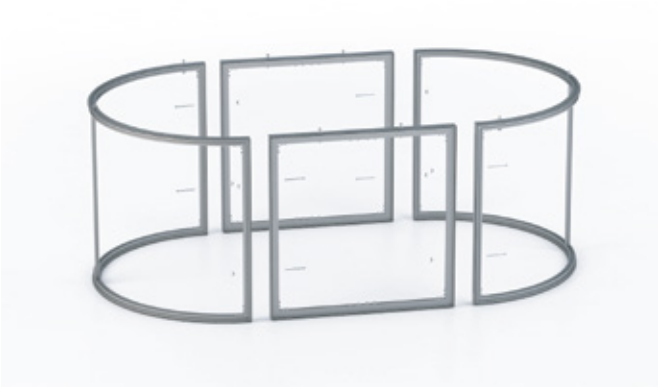

200(d)x100(h)cm consisting of 4 parts 1(r)m



Rounded rectangle 4x3x1m with 1(r)m



Cylindered

300(d)x100(h)cm consisting of 4 parts 1.5(r)m

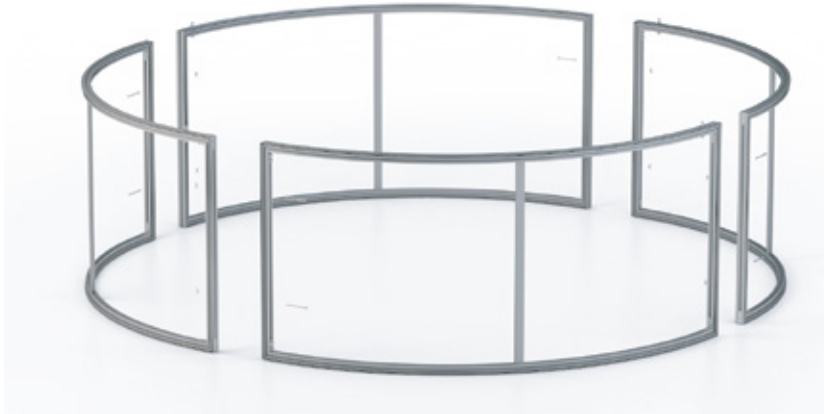

400(d)x100(h)cm consisting of 6 parts 2(r)m

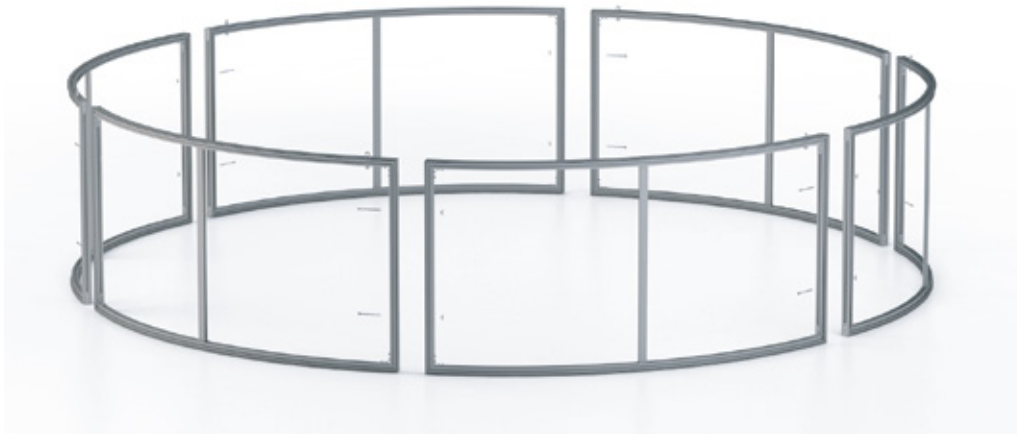

500(d)x100(h)cm consisting of 6 parts 2.5(r)m

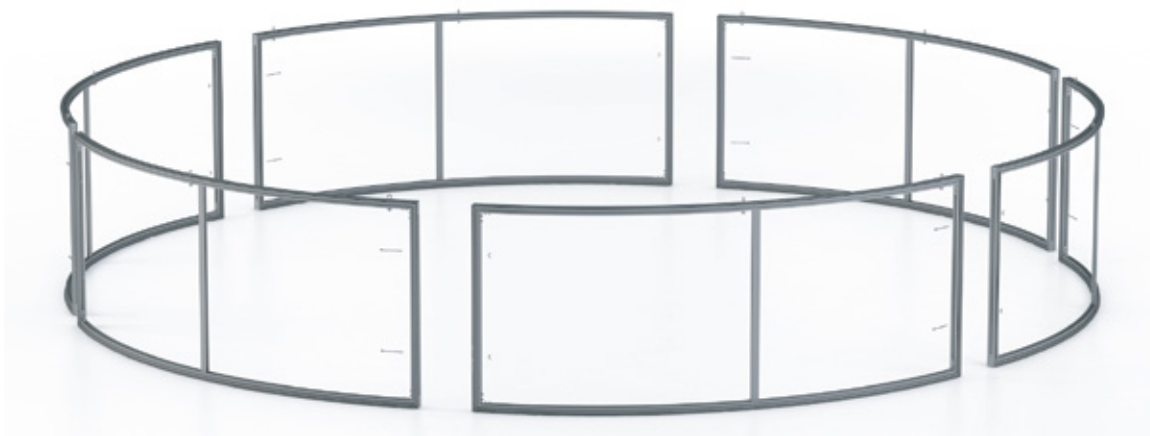

Available LED modules

M/H/0009 0.5x0.5x1m - Corner



M/H/0010 1x1m



M/H/0031 1.5x1m



M/H/0011 2x1m

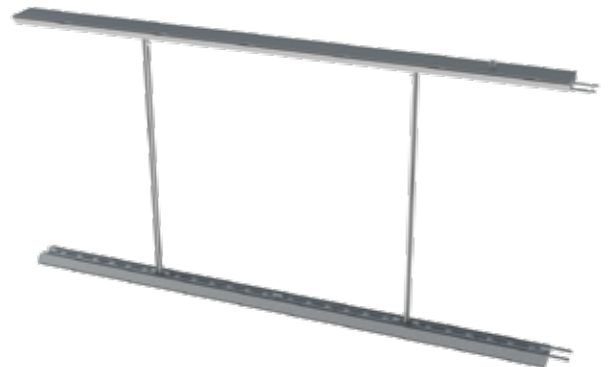

M/H/0012 0.5x1m - Ending set



- Each module has its own power supply meaning that every size from 1 to 25 meters is in our scope.
- Available heights: 1m & 1.5m

Fastening



Hanging Clip

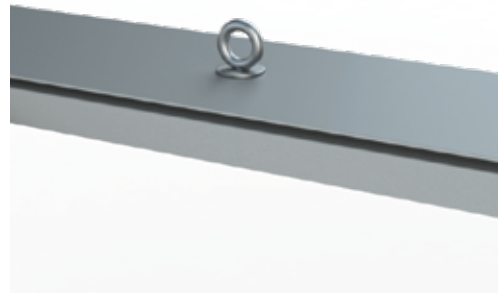

Printing view (outside)



Printing view (inside)



Hanging wire ropes

Wire rope 4mm



Wire rope with loops at both ends, 4mm thick.
With 1 safety hook.

- PART/0160
Lenght 100cm
- PART/0165
Lenght 150cm

Wire rope 3mm



Wire rope with loop at one end, 3mm thick.

- PART/0180
Lenght 120cm
- PART/0181
Lenght 200cm

Adjustable holder 3mm



Adjustable holder for wire rope 3mm thick.
With 1 safety hook.

- PART/0179
- Combined with wird ropes PART/0180
& PART/0181

Wire rope 4mm



Wire rope with loop at one end, 4mm thick.

- PART/0182
Lenght 120cm
- PART/0183
Lenght 200cm

Adjustable holder 4mm



Adjustable holder for wire rope, 4 & 5mm thick.
With 1 safety hook.

- PART/0184
- Combined with wire ropes PART/0182
& PART/0183

Applications



Applications

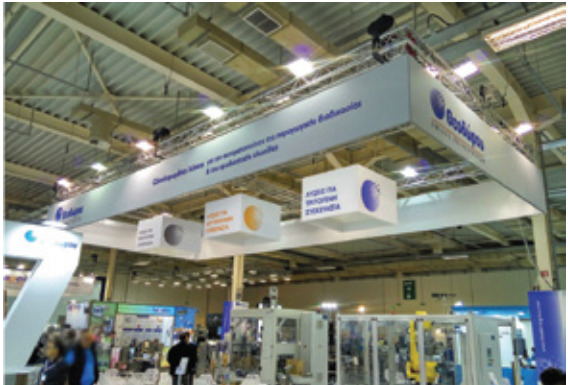

Applications



MULTIPLA PRODUCTS



BACKDROPS



VOLUMES



WALL PANELS



EXHIBITION BOOTHS



PROMO STANDS



CEILING PANELS



▲ 23 Notara str, Ag. Dimitrios Athens 173 43

T +30 210 9753 140

www.multiplo.gr

www.evin.gr